



ALCHEMY

Installation & User Manual

Model: FB18-MKIII

Please read this manual carefully for correct installation, use and maintenance of the appliance.

Operate the appliance in accordance with the instructions provided.

The appliance is in compliance with BS EN 16647.

**IMPORTANT SAFETY NOTICE: BIO-ETHANOL FUEL
MUST BE BETWEEN 85% - 96.6% ALCOHOL**

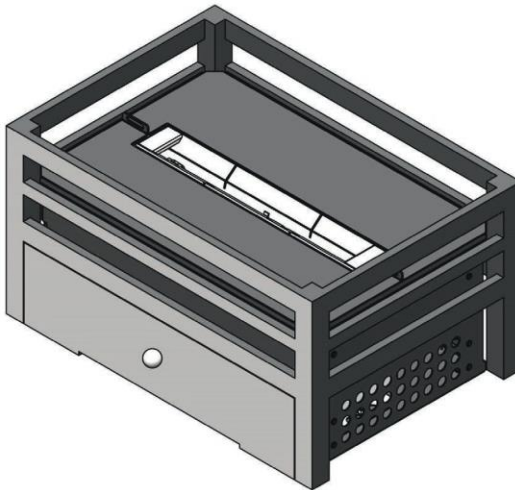

Contents

1. Supplied Parts.....	4
2. Safety Information.....	6
3. Installation	8
4. Operating the Appliance.....	13
5. Safety Systems	16
6. Maintenance	17
7. Technical Information.....	18
8. Troubleshooting.....	19
9. Appendices	
Appendix 1 – Remote Control	23
Appendix 2 – Dimensions and Spare Parts	27
10. Installer Checklist	29
11. Warranty Registration	30

1. Supplied Parts

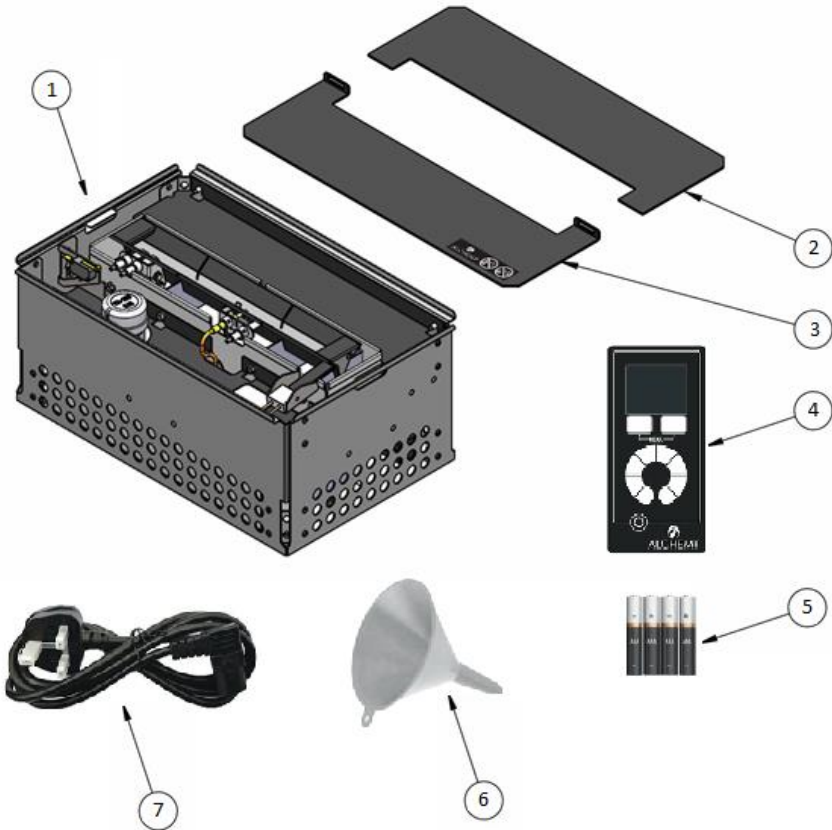

ITEM NO.	DESCRIPTION	QTY.
1	FB18-MKIII	1
2	TOP PLATE - FRONT	1
3	TOP PLATE - REAR	1
4	RC HANDSET	1
5	4x AAA Batteries	1
6	Fuel Filling Funnel	1
7	AC 220V – 240V Mains Power Cable	1

Log Plate and Ceramic Logs

Complete Log set

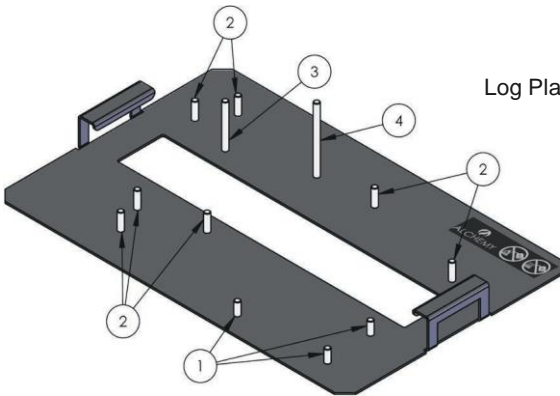

Log Plate showing pin locations.

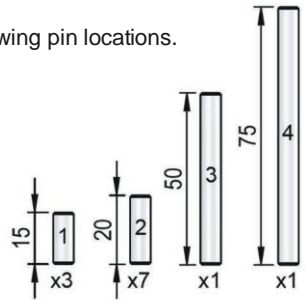

Individual Ceramic Log

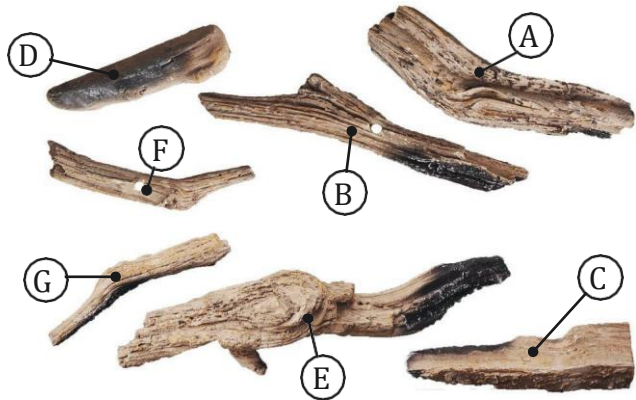

2. Safety Information

- To avoid injury do not touch the appliance while in operation or when it is hot.
- Keep children, animals and unauthorised persons away from the appliance. Never leave children unsupervised while the appliance is in operation or when it is hot.
- No items are to be placed on the appliance.
- Keep appliance away from flames, ignition sources, and flammable materials.
- Do not attempt to move the appliance while in operation.
- Never pour bioethanol fuel over live flames.
- After turning off the appliance it will take a few minutes for the flames to extinguish.
- After turning off the appliance wait at least 5-10 minutes before attempting to re-ignite.
- Always ensure the flame is fully extinguished before refuelling as the flame may be difficult to see in different environments.
- The appliance uses bioethanol fuel only, which is a flammable liquid. Store in original container away from heat and sources of ignition. Follow container directions for use and safety.
- Bioethanol fuel is classified as a flammable liquid Class 1B (for flammability) and Class 3 PGII (for transportation) and is regulated by various standards around the world. You must familiarise yourself and comply with these regulations in order to safely and legally store, handle, decant and use this fuel.
- Use only approved bioethanol fuel that contains 85%-96.6% alcohol. Poor quality of fuel may lead to undesirable results, reduction in reliability, incomplete and inefficient combustion, smoke and odours, residues inside the burner.
- Alchemy Ltd is not liable for any damage caused by using the incorrect type of fuel.
- Do not refuel while the appliance is still hot. Allow at least 30 minutes before refuelling.
- Never smoke or have naked flames near the appliance while refuelling or starting the appliance.
- Clean bioethanol fuel spills immediately with a dry cloth followed by a cloth dampened with water. Avoid any naked flames and allow to dry completely before using the appliance.
- Store fuel only in original container. Store away from area where the appliance is located at minimum distance of 200cm. Transport and/or store fuel only in a plastic or metal container that is acceptable for use with the fuel and non-red in colour.
- Do not operate in a room with oxygen tanks in use or if flammable vapours are present.
- Do not place in areas where there might be a potentially explosive atmosphere of paint vapours, industrial dusts, etc.
- For decorative purposes only. Not suitable for continuous operation. Do not use the appliance to heat or boil water or as a cooking appliance. Do not put wood, charcoal, paper or other combustible objects in the flames.
- Do not position the appliance near windows, doors, vents or fans that can create draughts as this may cause irregular operation.
- Do not place the appliance in close proximity to sources of humidity.
- For indoor use only, do not expose the appliance to external weather conditions.
- Do not install in a passive house.
- Bioethanol combustion releases carbon dioxide (CO₂) and water (H₂O). The combustion requires oxygen, therefore the area where the appliance is placed should have adequate ventilation to allow for fresh air circulation.
- To prevent the risk of indoor air pollution, the room in which the appliance is to be installed must have sufficient ventilation to ensure air exchange in the room at least once per hour. Improper ventilation can cause serious injury or death.
- No heat sensitive and flammable items can be placed in direct contact or within a radius of 1m / 3.28ft from or above the appliance.
- Do not obstruct the ventilation slots/air inlet grilles of the appliance.
- You must have a carbon-dioxide (CO₂) or dry powder extinguisher placed nearby the appliance.

- In case of uncontrolled flames, please use a fire blanket or carbon-dioxide (CO2) or dry chemical extinguisher.
- Do not use water to extinguish the fire.
- Use only authorised accessories supplied by Alchemy Ltd.
- NON-COMBUSTIBLE pebbles, logs or other refractory decorative fire accessories should not be used.
- Do not use fittings or spare parts, other than those available from or recommended by Alchemy Ltd.
- Always isolate the power to the appliance before moving, cleaning or servicing.



DO NOT POUR OVER LIVE FLAMES



DO NOT FILL WHILE HOT

3. Installation

- While installing the appliance according to the instruction manual ensure local and national guidelines are observed.
- The appliance must be positioned on a flat and level surface.
- The elements of construction within a 1m radius of the appliance must be A1 classified non-combustible materials.
- The appliance must be installed level within +/-1mm.
- A power supply is required.
- Installation must allow for easy removal of the appliance for servicing.
- Do not fill the fuel tank or use the appliance before the installation is complete.

For reasons of safety, under no circumstances can there be any flammable material within a 1m radius from the appliance. The manufacturer does not recommend positioning any heat sensitive materials or devices above the appliance as it can significantly limit the materials' properties and lifetime. The manufacturer will not bear any responsibility for damage to heat sensitive materials or devices installed above the appliance.

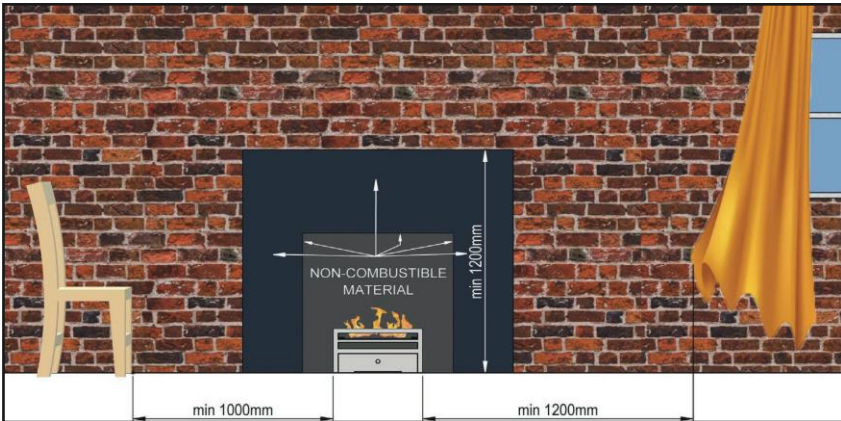

Ensure heat sensitive devices and combustible materials are a minimum of 1000mm away from the appliance.

IMPORTANT DEFINITION:

Non-Combustible material: A material that does not react to heat.

- Any material which when tested to BS 476-11:1982 (2007) does not flame nor cause any rise in temperature on the centre (specimen).
- Products classified as non-combustible in tests following the procedures in BS 476-4:1970 (2007).
- Any material classified as class A1 in accordance with BS EN 13501-1:2002 Fire classification of construction products and building elements. Classification using data from reaction to fire tests.

PLEASE NOTE THAT TIME RATED PLASTER BOARDS OF ANY TYPE ARE NOT SUITABLE FOR THIS CONTRSRUCTION, WE RECOMMEND ONLY CALCIUM SILILCATE & VERMICULITE BASED BOARDS RATED TO A1.

VENTILATION

- Bioethanol combustion requires oxygen (O₂) and releases carbon dioxide (CO₂) and water (H₂O).
- It is important to ensure there is adequate ventilation in the area that the appliance is installed to ensure there is a fresh air supply and a healthy level of oxygen to allow for one room volume change of air per hour. This can be achieved with air bricks/vents or any other means.
- There must always be free movement of air all around the appliance.
- It is not recommended to enclose the appliance.
- The minimum room size that the appliance can be installed in is **25m³**.
- To calculate the room size, measure the height, length and width and multiply all measurements. e.g. (L) 6.6m x (W) 3.8m x (H) 2.4m = 60.192m³.
- **For new build and renovated properties with a lower air permeability it is necessary to provide ventilation to the room of the appliance from an external space as per Document F Building Regulations.**

INSTALLATION IN A CHAMBER

- The minimum chamber dimensions are 750mm wide x 750mm high x 350mm deep (see Figure 1). This is to ensure sufficient free flowing air to prevent excessive heat build-up and damage to the appliance.
- Ensure the chamber is constructed from non-combustible materials. Any stud work introduced must be non-combustible materials. Any voids within the chimney breast or above the appliance are recommended to be ventilated to prevent heat build-up with continuous use.
- If installing where there is an existing flue, ensure the flue is completely sealed from both above and below the appliance to prevent draughts causing an adverse effect on the appliance. When sealing the flue steps should be taken to avoid the possibility of damp and condensation build up in the flue by means of ventilation in another area from where the appliance is installed.
- It is recommended that a front hearth is installed with a minimum thickness of 12mm and a minimum depth of 300mm as per Figure 1.
- If installing with a timber surround the opening of the surround must be a minimum of 915mm wide x 915mm high, and the use of slips in a non-combustible material with a minimum width of 165mm for the top slip and 82.5mm for the side slips is required.
- The air inlet holes around the appliance must not be obstructed.

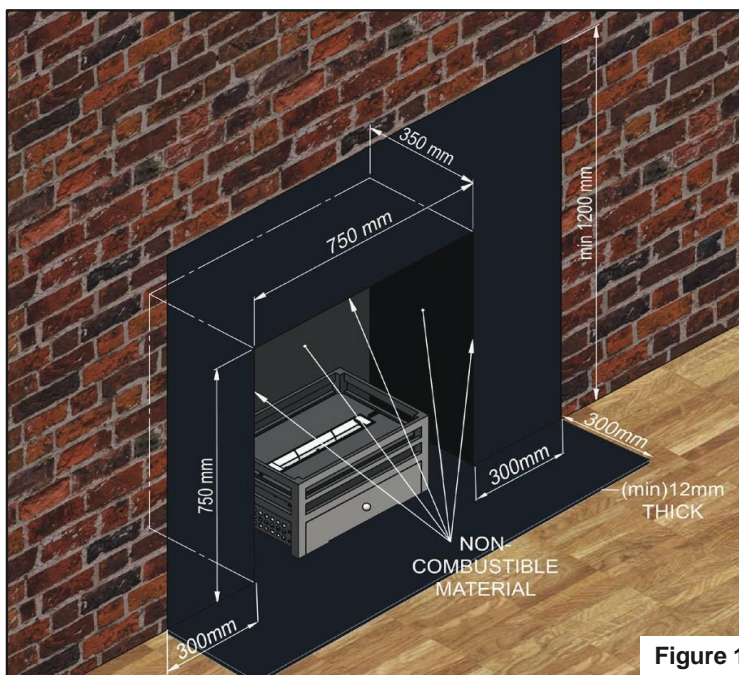

INSTALLING THE APPLIANCE

- A 13A switched mains socket is required to power the appliance.
- If the socket is to be located in the chamber it must be below the highest point of the appliance.
- The socket must be accessible at all times. If there are access issues to the socket an external switched spur can be introduced, which must be accessible at all times.
- It must always be possible to isolate the power to the appliance.
- Do not connect to the mains power supply until after the appliance is safely installed in the final position.
- When in position check the appliance is level. (See Figure 2)
- Once the unit is safely installed turn on the power supply. There should be two audible beeps to signify there is power to the unit.
- Place the top plates in position on top of the appliance.

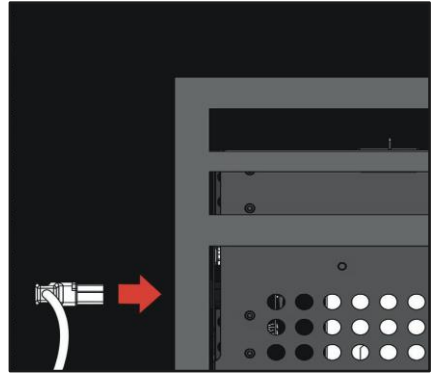

LEVELLING THE APPLIANCE

- The appliance must be level within +/-1mm to ensure an even flame spread.
- If the flame is weaker on one side or does not cover the full width of the burner channel while on the high setting, it will be necessary to level the appliance by using the levelling feet – See Figure 2.
- A 4mm allen key and a spirit level is required for adjusting the grub screws underneath the unit.

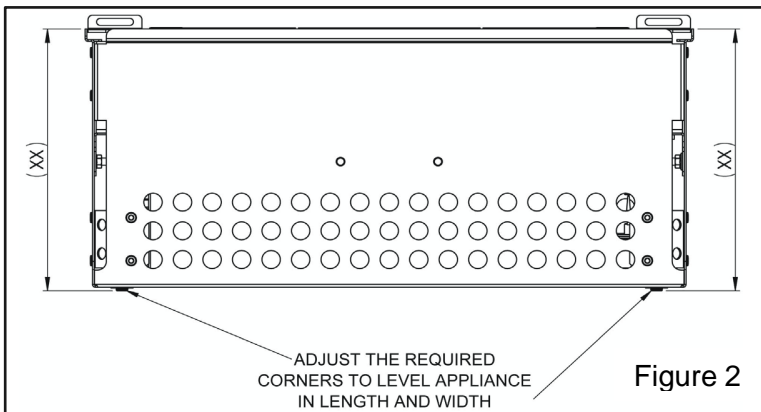

CERAMIC LOG LAYOUT

- **IMPORTANT: when using the log set remove the top plates from the appliance.**
- Please handle the logs with care as they are fragile.
- Please ensure the logs are only placed on the correct pins on the top plate.
- The logs must not cover or interfere with the burning area or flames in any way as otherwise it could cause the appliance to overheat causing damage.
- Do not put bio-ethanol fuel on the ceramic logs.

First layer of ceramic logs: A, C, F, G.

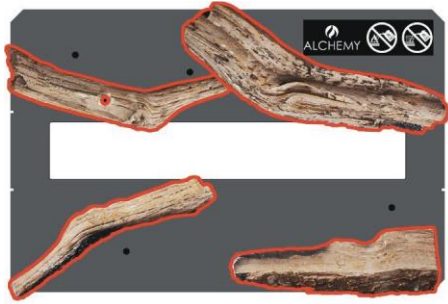

Place second layer of ceramic logs: B, E.



Last ceramic log making up third layer: D.



4. Operating the appliance

FUELLING THE TANK

Always ensure the appliance is cold before fuelling the tank and use the correct fuel.
For first use it is recommended the tank is filled to it's maximum capacity.

1. Remove the top plate/log plate and unscrew the fuel tank cap.

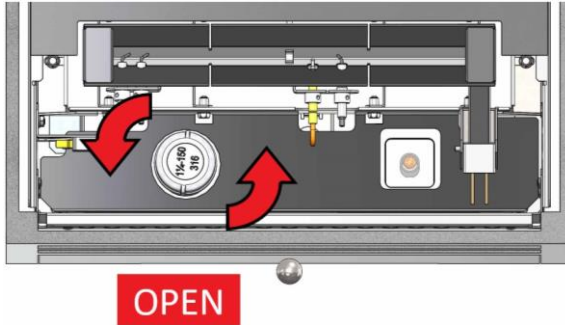

2. Insert the funnel into the fuel tank neck and carefully pour bioethanol fuel into the tank until the indicator ball level reaches the top of the tank window.

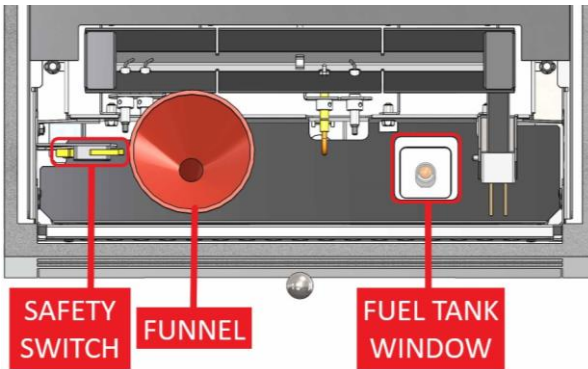

3. Replace the fuel tank cap ensuring it is firmly closed and replace the top plate.

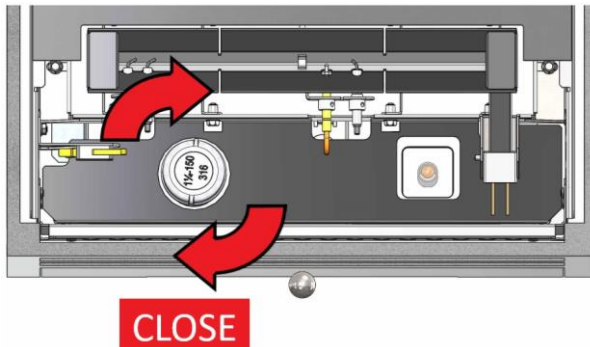

OPERATING THE REMOTE CONTROL

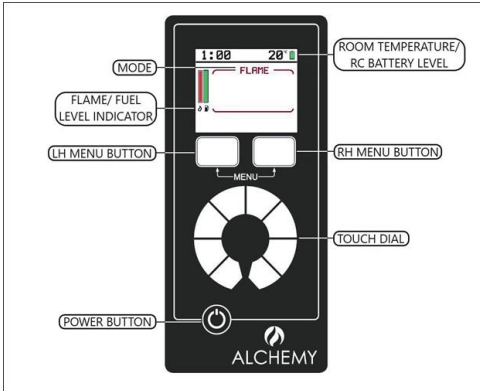

- A. Touch power button to awaken handset.
- B. To turn on, hold power button until bar fills. The screen will display PRIMING for about 45 seconds.
- C. When the flame has established the unit will beep and the screen will display the level of heating.
- D. To increase flame intensity touch power button to awaken handset and rotate touch dial clockwise.
- E. To reduce flame intensity touch power button to awaken handset and rotate touch dial anti-clockwise.
- F. To turn off, touch power button to awaken handset. Hold power button until red bar fills. The appliance will take around 2 minutes to burn off any residual fuel.

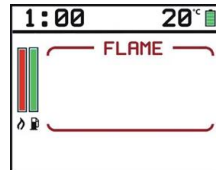
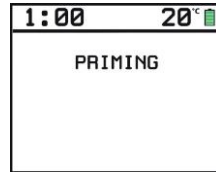
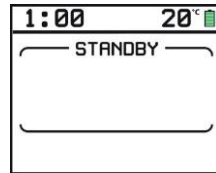

Burner is priming when the glow plug is heating up and the fuel starts pumping out, as shown in the image.



Once the glow plug reaches required temperature and reached by the fuel, the flame will ignite.



FUEL NOTIFICATION

When the tank is empty or does not have enough fuel, there will be an audible beep and a message of NO FUEL will appear on the display screen.

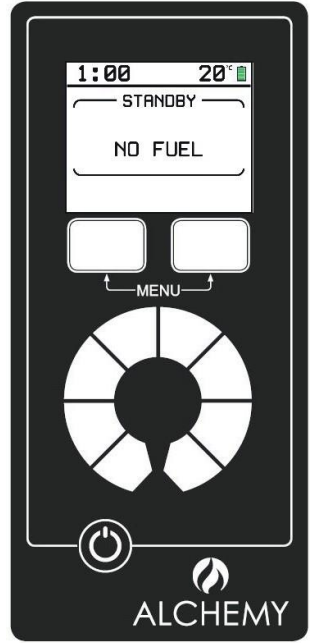

When there is sufficient fuel in the tank for the appliance to operate, the fuel indicator will show a green bar.

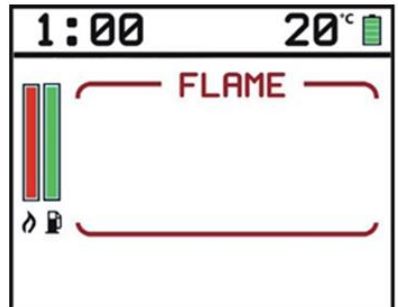

5. Safety Systems

LEAK DETECTION SENSOR

The appliance has a leak detection sensor located underneath the burner on the lowest part of the sump as per image showing the sensor location. Thus, if there is a leak the appliance will turn off. A loud beep will sound if the safety is activated.

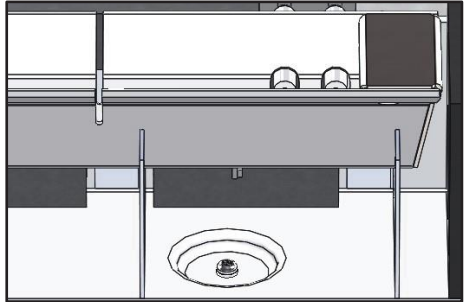

OVERFLOW DETECTION SENSOR

The appliance is equipped with an overflow sensor which is designed to ensure user safety when accidental damage occurs to the pump or electronics. In case of excess fuel being pumped into the burner the sensor will be activated and will shut off the appliance. The appliance will not light until it is reset by switching the mains power supply OFF, wait 10 seconds, then switch ON.

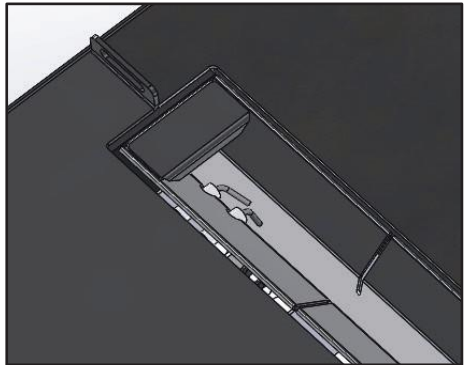

BIOETHANOL FUELLING DETECTION SWITCH

You will not be able to fill up the fuel tank while the appliance is on due to the safety micro-switch. Removing top access panel will trigger the switch and extinguish the flames. A message 'Lid Open' will appear on your handset. In order to light the appliance you must replace the top plate in its position covering the fuel tank side.

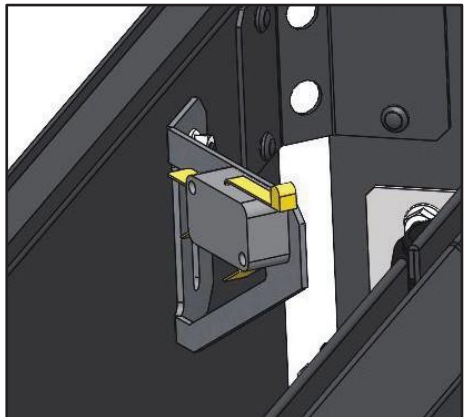

6. Maintenance

ALWAYS UNPLUG OR ISOLATE FROM MAINS SUPPLY BEFORE CLEANING OR UNDERTAKING ANY MAINTENANCE.

Turn the appliance off and isolate the mains supply. Ensure the appliance is cold before attempting any maintenance of the appliance. No liability can be accepted by Alchemy Ltd for injury caused by burning or scolding by a hot appliance.

It is suggested the follow procedures and checks are carried on a regular basis:

- A. Use a vacuum cleaner to clean the top of the burner and metal top plates.
- B. Remove metal top plate and wipe with a dust cloth.
- C. Check the burner channel is clear of any debris and no foreign objects are in contact with the safety sensors.
- D. Replace metal top plates.
- E. Check the safe operation of the appliance.

It is highly recommended that your appliance is turned on at least once a month for 10 minutes, even during summer months. This will ensure the appliance is in good working order. Please check battery levels in the remote control and replace as required.

7. Technical Information

BIO-ETHANOL		FB18
GROSS INPUT on High	(Hs) (kW)	3.5
Ethanol Consumption on High	(L/Hr)	0.5
GROSS INPUT on Low	(Hs) (kW)	2.5
Ethanol Consumption on Low	(L/Hr)	0.35
Fuel Tank Volume Capacity	(L)	3.2

These values are indicative only and may vary depending on the installation and denatured ethanol used.

- A minimum of 0.5L bio-ethanol fuel is required to operate the appliance.
- 15% of the total tank capacity will remain in the fuel reservoir in order for the unit to operate.

8. Troubleshooting

8.1 There is smoke or a foreign smell coming from the appliance when burning

- There may be waste burning that should not be in the burner channel.
- You are using the wrong fuel (it is essential that you ONLY use Bioethanol).
- You have placed something around/above the flame that has not been approved or recommended.
- If the appliance has run out of fuel and the flame is burning out or you have just turned the appliance OFF, this is normal.
- Poor quality fuel is being used.

SOLUTION

Turn the appliance OFF and wait until it cools down. Clean/service the appliance and remove debris/waste. Contact your local distributor for fuel brand recommendation.

8.2 When I attempt to light the appliance it does not start

- You have not put enough fuel in the appliance.
- You have not used the correct fuel (it is imperative that you ONLY Bioethanol fuel).
- The appliance opening is obstructed, there needs to be adequate ventilation for the flame to start.
- The appliance is cold and takes time to ignite.

SOLUTION

Check Stop Code – in the DEVICE menu on the handset for further guidance. Check fuel level by inspecting through the fuel tank window, check type of fuel used. Repeat starting procedure until the appliance warms up and remains ignited.

8.3 I have spilt some fuel, what do I do before lighting?

Use the isolation switch to prevent the fire turning ON. Keep people away from the area. Wipe up spilt liquid thoroughly using a dry cloth, wipe again with a cloth dampened with water. Avoid breathing vapours. Ventilate enclosed space by opening windows and doors. If fuel was spilled on hands, wash thoroughly. Only use the appliance when the area is completely dry and you are certain that all spilt fuel has been removed. Please refer to MSDS for Bioethanol.

8.4 The flame is unusually volatile and high

This is likely to be caused by a strong draught.

Turn OFF the appliance. Locate and remove the source of the draught (it may be that you have a window/door open or fan operating that is directly pushing air towards the appliance).

8.5 RC Handset Fault Finding

The software installed will give an error/ stop coded if the bioethanol fire stopped or did not start from any reason. If the appliance stops a code is generated, and can be read on the handset.

The code number will help to see at which stage in the ignition process or operating the fault has happened.

To find the Stop Code: on the remote press both Menu buttons together until the MENU appears with three options. Rotate the dial until DEVICE is highlighted in RED and press select. For further information on Remote Control functions see Appendix 1.

The display will show the version number and the stop code as follow:

Display “Rxxx.Dxxx.SCx”

R = Receiver software version number.

D = Device software version number.

SC= stop code in hex format (as shown below).



1 Top plate not aligned – switch active

- Reason: Top plate not sitting on the fire box properly after being removed or being knocked.
- Solution: Align top plates, and make sure they are in correct position.

2 No fuel reaching tank sensor (IGNITION PROCESS)

- Reason: Not enough fuel in tank.
- Solution: Put more fuel into the tank.

3 Thermocouple hot – Hot Tray (IGNITION PROCESS)

- Reason: Appliance has recently been turned off or top plate safety switch activated.
- Solution: Wait 5 minutes to try turning on again

4 Two minutes safety break (IGNITION PROCESS)

- Reason: The thermocouple safety sequence (3 – Thermocouple hot) has not completed.
- Solution: Wait another 2 mins to try turning on again.

5 Low level sensor not reached, pump timed out

- Reason: The fuel has not reached the low level sensor in the burner during operation due to fuel running out, blockage in the fuel lines, debris in the burner or faulty pump.
- Solution: Check for leaks, around fuel tank. Check fuel, refuel if no fuel. Check burner for debris and clean if required as per section **6. Maintenance** in manual. If leak found or still doesn't turn on after refuelling, call engineer/dealer to check fuel lines and pump.

6 High level sensor not reached, pump timed out

- Reason: The fuel has not reached the high level sensor in the burner during operation due to fuel running out, blockage in the fuel lines or faulty pump.
- Solution: Check for leaks, around fuel tank. Check fuel, refuel if no fuel. If leak found or still doesn't turn on after refuelling, call engineer/dealer to check fuel lines and pump.

7 Timed out wait for fuel low level (IGNITION PROCESS)

- Reason: The fuel has not reached the low level sensor in the burner during ignition process due to shortage of fuel, blockage in the fuel lines, debris in the burner or faulty pump.
- Solution: Check for leaks, around fuel tank. Check fuel, refuel if no fuel. Check burner for debris and clean if required as per section **6. Maintenance** in manual. If leak found or still doesn't turn on after refueling, call engineer/dealer to check fuel lines and pump.

8 Timed out wait for fuel high level (IGNITION PROCESS)

- Reason: The fuel has not reached the high level sensor in the burner during ignition process due to shortage of fuel, blockage in the fuel lines or faulty pump.
- Solution: Check for leaks, around fuel tank. Check fuel, refuel if no fuel. If leak found or still doesn't turn on after refuelling, call engineer/dealer to check fuel lines and pump.

9 Timed out waiting for flame (IGNITION PROCESS)

- Reason: Thermocouple did not get hot enough in required period as flame did not reach it during ignition process, due to fuel running out, blockage in fuel lines, debris in the burner or faulty pump.
- Solution: Check for leaks, around fuel tank. Check fuel, refuel if no fuel. Check burner for debris and clean if required as per section **6. Maintenance** in manual. If leak found or still doesn't turn on after refueling, call engineer/dealer to check fuel lines and pump

A. Timed out wait for high level after flame (IGNITION PROCESS)

- Reason: Fuel did not reach high sensor in the burner after flame on during the ignition process, due to fuel running out, blockage in fuel lines, debris in the burner or faulty pump.
- Solution: Check fuel, refuel if no fuel. Check burner for debris and clean if required as per section **6. Maintenance** in manual. If still doesn't turn on after refueling, call engineer/dealer to check fuel lines and pump.

B. Flame out (THERMOCOUPLE TEMP. DROP)

- Reason: Strong draught could have put the flame out or the thermocouple could be faulty.
- Solution: Remove source of draught and try relighting fire (after waiting for the safety sequence to finish). If fire still does not light, contact engineer/ dealer to check thermocouple.

C. Dropout from ignition program (IGNITION PROCESS)

- Reason: Software issue, program is corrupted.
- Solution: Contact dealer to get re-programmed.

D. Stop code received from RF RECEIVER

- Reason: The user has switched off the appliance.
- Solution: If the user requires for the appliance to be back just normal quick start procedure.

E. No fuel reaching tank level sensor (FIRE OPERATING).

- Reason: Fuel ran out and there is not enough fuel in the tank to keep appliance operating.
- Solution: Put more fuel into the tank.

The company reserves the right to make any product upgrades or improvement without prior notice.

9. Appendices

APPENDIX 1 - REMOTE CONTROL

The appliance is in Standby mode when the power is switched on. You must have the power supply ON (—) before using the handset. The remote control works by radio signal which is configured at the factory with a unique signal code.

IMPORTANT: If your handset loses signal or needs to be replaced then the frequency will need to be reprogrammed. Follow instructions 1.1.1 DELETING DEVICE and 1.1.2 PAIRING DEVICE

The handset will go into Power Save mode when not in use. Press the power button to reactivate. When turned on the appliance automatically defaults to the last setting selected.

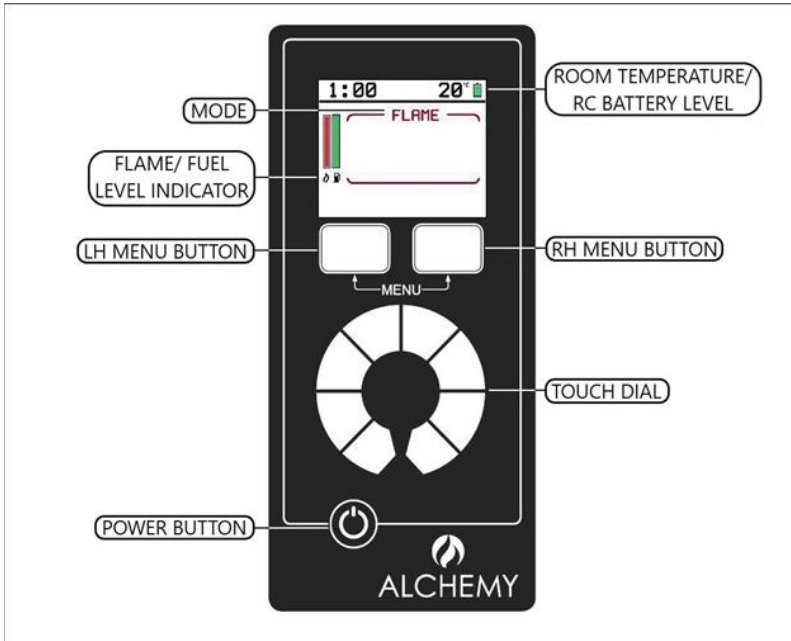

1. Remote Control Functions

Press both Menu buttons until a menu appears at top of screen. Three screen options will appear. To select options rotate dial until highlighted in RED and press select.

- SET CLOCK
- DEVICE
- ADVANCED

1.1 SET CLOCK

- Select CLOCK in the option menu and rotate touch dial until desired time is displayed.
- By pressing select it changes from Hours, Minutes and Days.
- When correct time has been set, press the RH Menu button to save.

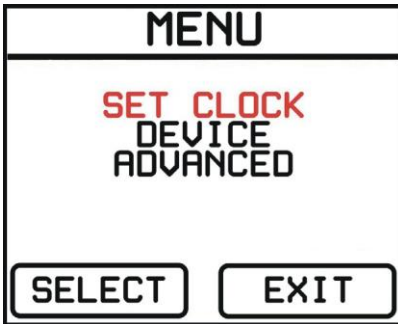

1.1.1 DELETING DEVICE

- I. Scroll to DEVICE menu and press select.
- II. This gives details of the appliance and also gives the option to delete the appliance from the remote handset. Press and hold the delete option to remove appliance.
- III. Once the deletion process completes, the handset will show NO PAIRED DEVICE. By selecting EXIT options to the main screen, the PAIRING selection will appear.



1.1.2 PAIRING DEVICE

To pair a handset (existing or new) to the appliance the current pairing program must be deleted (as shown previously).

- I. Ensure appliance is switched OFF and isolated from mains power.
- II. Touch power button on the remote panel.
- III. Select PAIR option on remote.
- IV. Switch ON mains powers to the appliance.
- V. The remote screen will show STANDBY when successful.

NOTE: The handset screen will show SEARCHING if the appliance is not plugged in and switched ON.

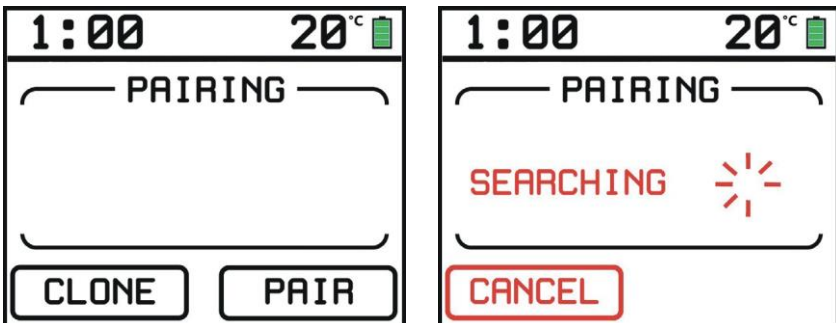

NOTE: The 'CLONE' button is not used.

1.2 ADVANCED

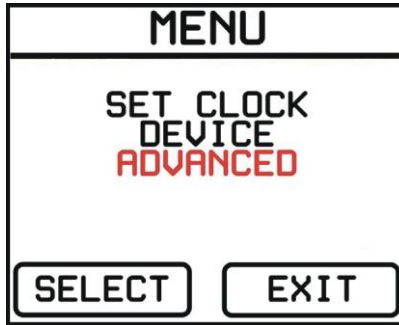

1.2.2 SCREEN DIMMER

- I. Scroll to ADVANCE menu and press select.
- II. This function dims the screen of the remote. To switch dimmer on or off press SET option to toggle between ON and OFF.

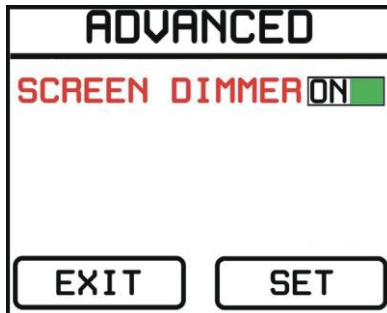

APPENDIX 2 - DIMENSIONS AND SPARE PARTS

DIMENSIONS

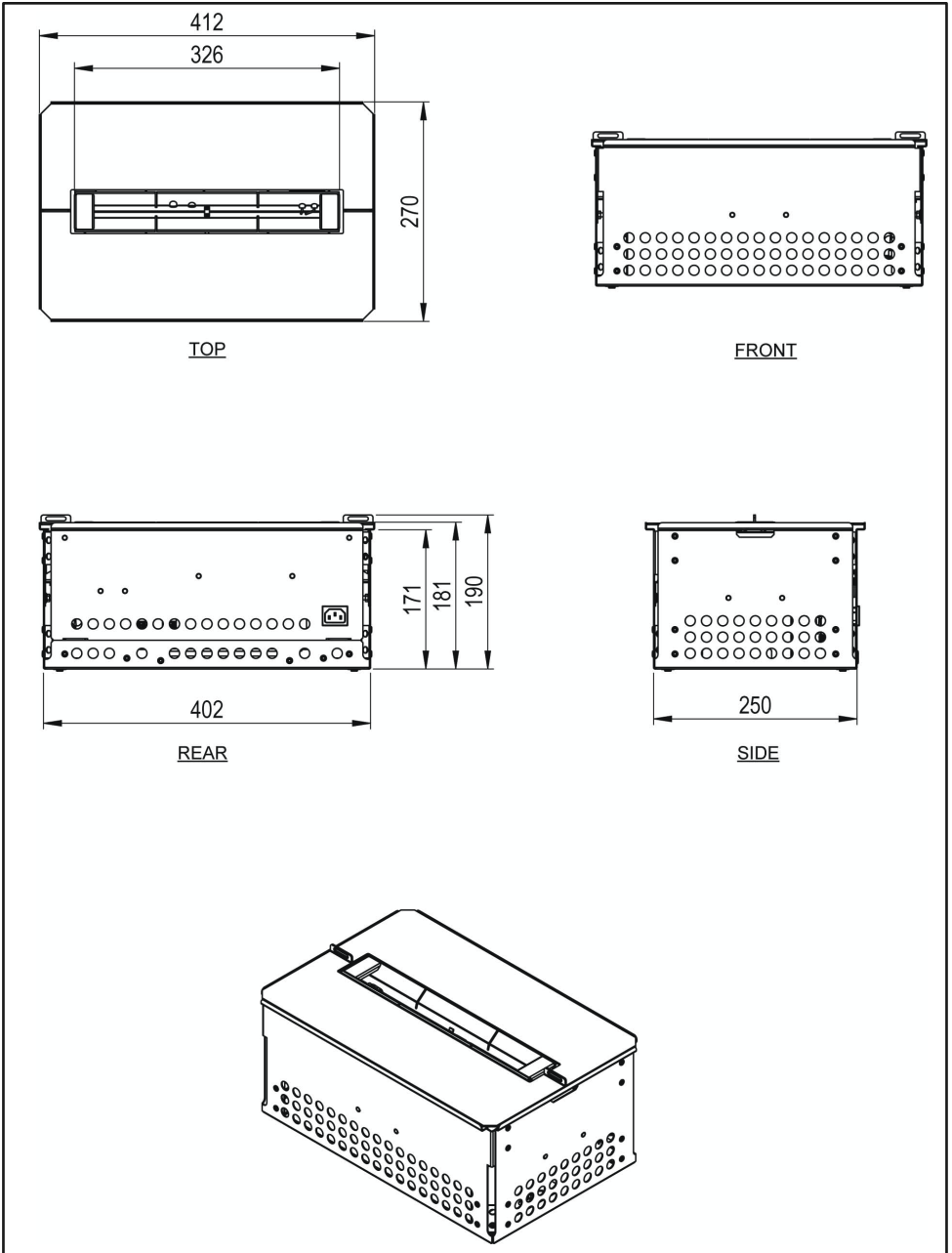

SPARE PARTS

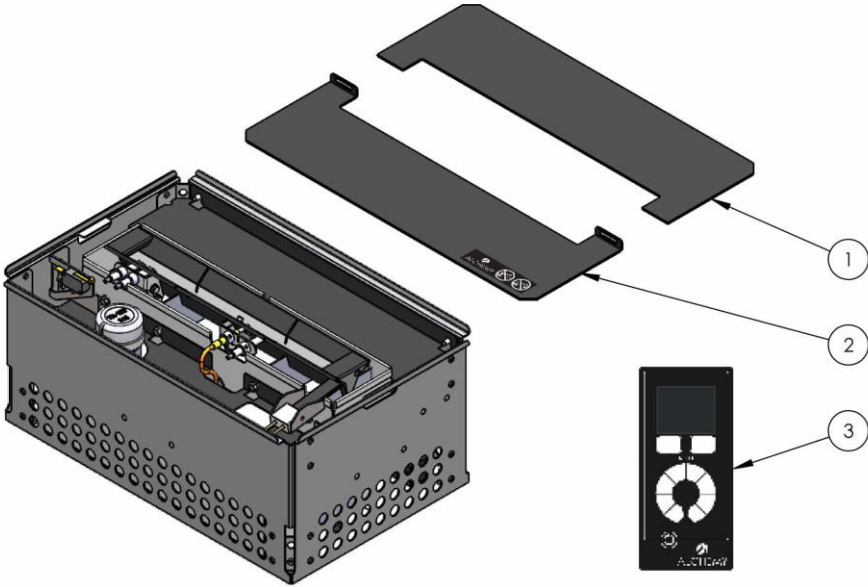

ITEM NO.	PART NUMBER	DESCRIPTION	QTY.
1	FB18-007	TOP PLATE - FRONT	1
2	FB18-008	TOP PLATE - REAR	1
3	FB18-014	RC HANDSET	1

10. Installer Checklist

THE BELOW FORM MUST BE COMPLETED BY THE INSTALLER ON COMPLETION AND IS REQUIRED IN THE EVENT OF A WARRANTY CLAIM

Date:

Serial Number:

Installation Address:

Are the elements of construction within a 1m radius of the appliance A1 classified non-combustible? PLEASE NOTE: TIME-RATED PLASTER BOARDS ARE NOT SUITABLE	Yes	No	If NO, DO NOT commission until it meets these requirements. Check the installation instructions on p.8.
Are all heat sensitive and combustible materials a minimum of 1000mm away from the appliance?	Yes	No	If NO, DO NOT commission until the materials have been moved.
Is the room size the appliance is being installed a minimum of 25m³?	Yes	No	If NO, DO NOT commission. If YES, Please confirm your room size and calculations:
If the appliance is installed in a new build or renovated property has the correct ventilation been provided as per Document F Building Regulations?	Yes	No	If NO, ensure that the correct ventilation is provided as per Document F Building Regulations.
Does the installation allow for the free movement of air all around the appliance, as per the Ventilation requirements?	Yes	No	If NO, DO NOT commission and check p.9 of the installation instructions.
If the appliance is installed in an existing chamber/opening has the flue been sealed?	Yes	No	If no, DO NOT commission until the flue has been sealed to prevent a draught above and below the appliance. A smoke match can be used to detect a draught.
Is there access to isolate the power to the appliance at all times?	Yes	No	If NO, DO NOT commission and review installation to ensure there is always access.
Is the appliance level?	Yes	No	If NO, DO NOT commission until level by adjusting the feet/grub screws while using a spirit level.
When the appliance is first connected to power, is a double beep audible?	Yes	No	If NO, check the power supply is correctly connected, check the socket works, check the plug fuse.
Are you using bioethanol fuel with between 85%-96.6% alcohol content?	Yes	No	If NO, DO NOT use the fuel in the appliance. Only use the recommended fuel with the correct alcohol content.
Does the appliance ignite first time and look stable on low and high settings?	Yes	No	If NO, check for any draughts (windows, doors, vents) and remove the source as this can cause irregular operation.
Did the appliance function uninterrupted for a minimum of 45 minutes on first use?	Yes	No	If NO, check the Stop Code on p.20 in the manual.
Client handover and demonstration of unit completed	Print Name: Client Signature:		

Installer Name (PRINTED):

Installer Signature:

11. Warranty Registration

The appliance is covered by a 2-year warranty.

The warranty must be registered within 28 days of installing the appliance. Failure to register within this time period will result in the warranty reverting to void from date of installation.

Please complete the online form at the below website to register your warranty:

<https://chesneys.co.uk/warranty-registration>

In the event of a breakdown or claim you are required to contact the installer/dealer. They will need to investigate the matter and process the claim on your behalf if required.

It is recommended that your appliance is serviced annually by your installer.
The cost of annual servicing is not included in the guarantee.

PRODUCT MATERIAL INFORMATION/ SAFE DISPOSAL

The following substances, preparations or components should be disposed of or recovered separately from other WEEE in compliance with Article 4 of EU Council Directive 75/442/EEC.

Metal	Steel	Can be taken to a local recycling centre for reuse to reduce waste going to landfill.
	Cast Iron	
Glass		Can be taken to a local recycling centre for reuse to reduce waste going to landfill.
Vermiculite linings		Non hazardous material. Vermiculite can be crushed up and used for plant bedding and ash used for composting or disposed of at a local recycling centre for reuse to reduce waste going to landfill.
Rope seals/ Coal Fuel Effects/ Brick Effect, Ledgestone and Black Reed Liners		If the product contains any of the following: Rope seals, Coal Fuel Effects, Black Reed Brick Effect or Ledgestone Linings panels these items are made from Refractory Ceramic Fibre (RCF), a material which is commonly used for this application. Protective clothing is not required when handling these articles, but it is recommended to follow normal hygiene rules of not smoking, eating or drinking in the work area and always wash hands before eating or drinking. When servicing the appliance it is recommended that the replaced items are not broken up, but are sealed within heavy duty polythene bags and labelled as RCF waste. RCF waste is classed as stable, non-reactive hazardous waste and may be disposed of at a licensed landfill site.
Log Fuel Effects		Log Fuel effects are not considered hazardous to health, but are non-recyclable and must be disposed of in accordance to the rules in force.
Electrical components	(Fan kits etc if applicable)	Dispose of at a local recycling centre in accordance with the WEEE directive.