

CHESNEY'S

Bio-Ethanol Installation & User Manual

model: EFB22

Thank you for choosing this Chesney's Bio-Ethanol fire.
Please read this information guide carefully to be able to
safely install, use and maintain your product.

Contents

1. General Information	5
2. Installation	6
3. User Instructions	11
Operating Elements	13
Initial start-up	14
Flame size regulation	16
Device extinguishing	16
Subsequent start-up	16
Information and warning alert	17
Cleaning and maintenance	21
Disposal and recycling	21

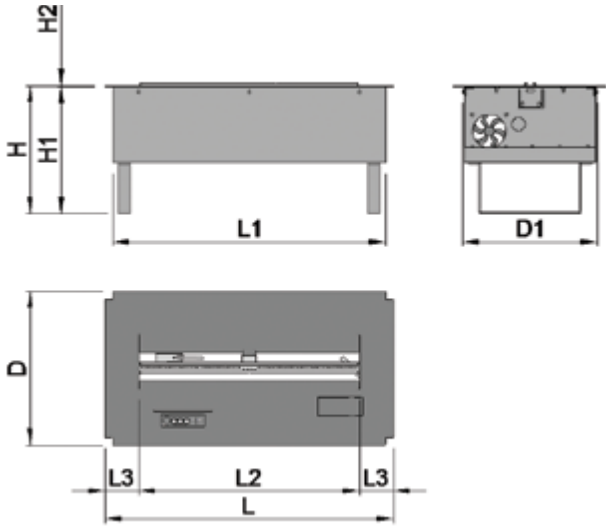
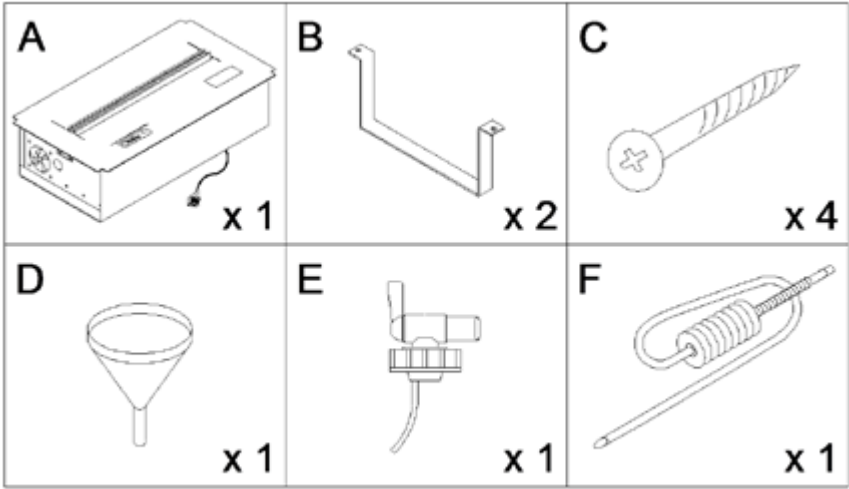

H	231mm (9 1/8")
H1	229mm (9")
H2	2mm (1/16")
L	522mm (20 9/16")
L1	494mm (19 7/16")
L2	400mm (15 3/4")
L3	61mm (2 3/8")
D	278mm (10 15/16")
D1	244mm (9 5/8")

Optional log set kit (sold separately)

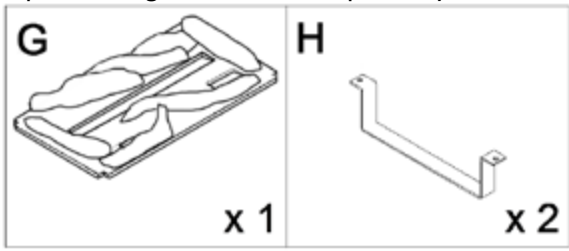

General information

- Do not install the device in areas with a cubic capacity of less than 58m³ / 2.049ft³ (22m² / 240ft² with a height of 2.6m / 8.53ft).
- Net weight: 11kg.
- While installing the device according to the instruction manual local and national guidelines are to be observed.
- The device must be placed on a level surface.
- Do not obstruct the ventilation slots and/or ventilators.
- No items are recommended to be placed on the unit except the log set provided by the manufacturer.
- Do not install the device in areas where there are large draughts drafts of air, near fans, vents, etc.
- Do not place in areas where there might be a potentially explosive atmosphere of paint vapours, industrial dusts, etc.
- No flammable items should be placed in direct contact or within a radius of 1m / 3.28ft of the device. Do not place near curtains, net curtains, etc.
- Do not expose the device to external weather conditions. The device is for indoor use only.
- Do not place the device in close proximity to sources of humidity.
- It is obligatory to have a carbon-dioxide (CO₂) or dry chemical extinguisher placed nearby the device.
- Installation of the device must allow for easy removal of the device for servicing.
- The room in which the device is to be installed must have sufficient ventilation to ensure air exchange in the room at least once per hour.
- Do not start the device before a full installation has been completed.
- Do not fill the fuel container before placing the device in its final position.

INSTALLATION

- After opening the packaging box leave the device inside the box for approx. 2 hours until it reaches room temperature. During this time familiarize yourself with the user's and installation manuals.
- The device is specially made to fit Chesney's 22" Fire Basket.
- The elements of construction above the device must be made of non-flammable materials.
- A loose cable min. $3 \times 0.75 \text{ mm}^2$, with power supply 230 V, 50 Hz, must be provided to connect the device to the mains.
- The device can be wired directly into a fused spur or alternatively a standard 3 pin 13 amp mains plug can be fitted (not supplied).
- If there is going to be a cover over the device, it must be made of non-flammable materials and the minimum distance from the device must be kept - not less than 35cm / 13 3/4".

For reasons of safety, under no circumstances can there be any flammable material within a 1m radius from the fireplace. Also, the manufacturer does not recommend positioning any heat sensitive materials or devices above the fireplace as it can significantly limit the materials properties and lifetime. The manufacturer will not bear any responsibility for the damage to heat sensitive materials or devices installed above the fireplace.

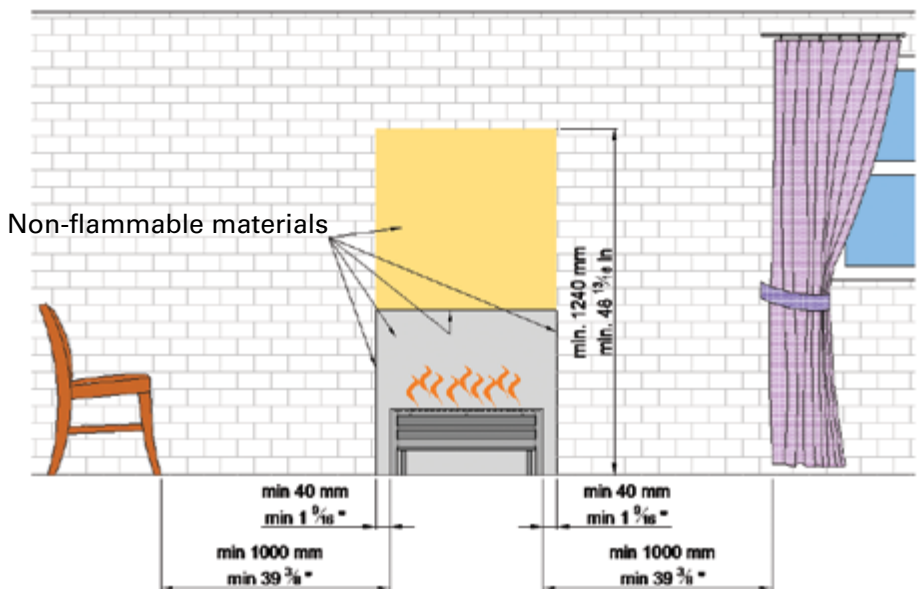
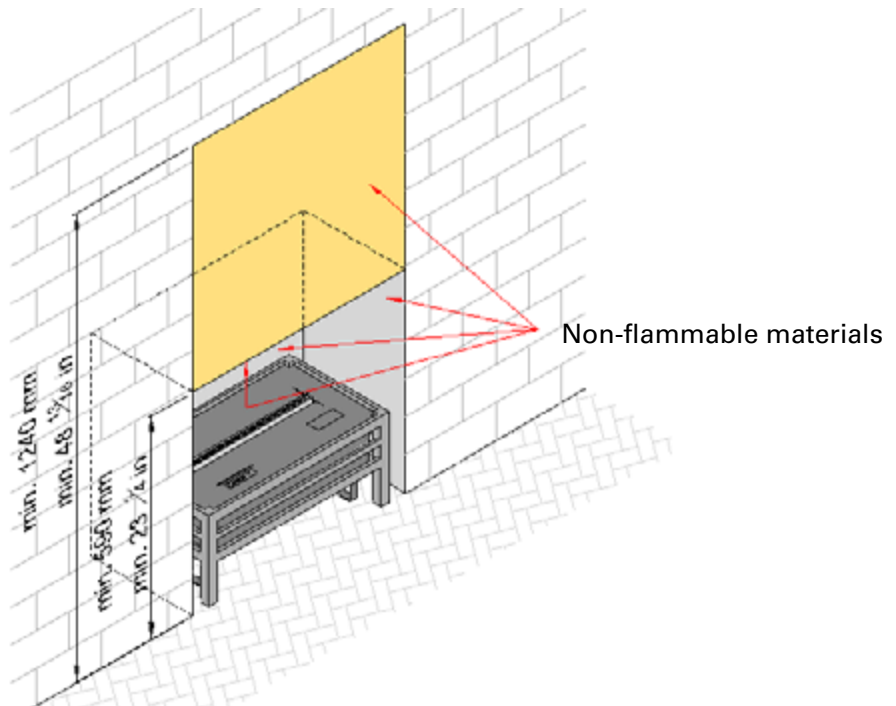

Installation with supports:

Make a cavity for the insert. Make sure that the base on which the device is to be placed is level, as later it will not be possible to level the fireplace. The difference in level between the ends of the device must not exceed 2mm. Poor levelling may cause abnormal operation of the device and, in extreme cases, it can cause leaks of the bio-ethanol fuel resulting in the danger of fire.

Fix the supports (B) to the bottom cover of the fireplace.

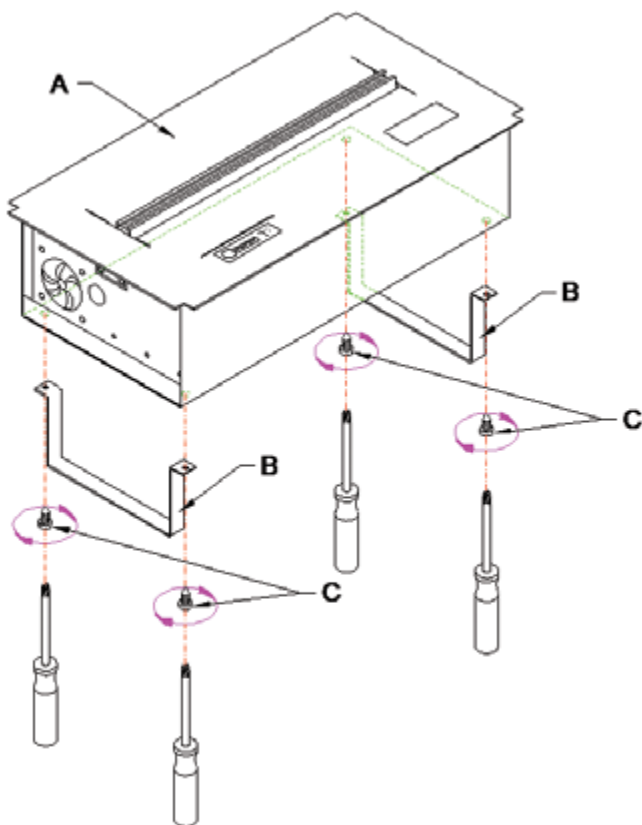

Then connect the supplied cable with a connection block at the end of the cord. Note that connection to the mains must be made by a qualified electrician. When the device has been connected to the mains it can be placed in the fire basket.

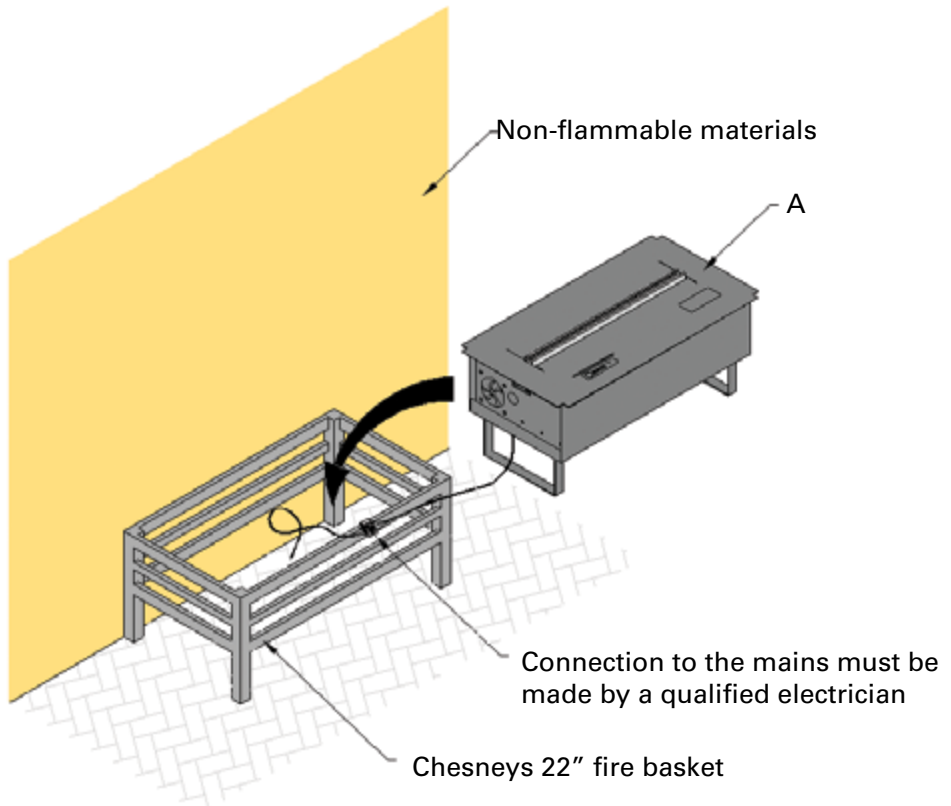

Installing with EFB22 Log Set (optional, sold separately):

If installing the unit with the optional log set (sold separately), use the shorter supports (H) supplied as part of the log set kit.

- Locating pins on the metal top plate will ensure that each log sits in the correct position.
- Logs must only be handled using the gloves provided.
- **IMPORTANT:** Logs MUST be placed onto the metal top plate in the following order: **C - B - A - F - E - G - D**, see diagram below:

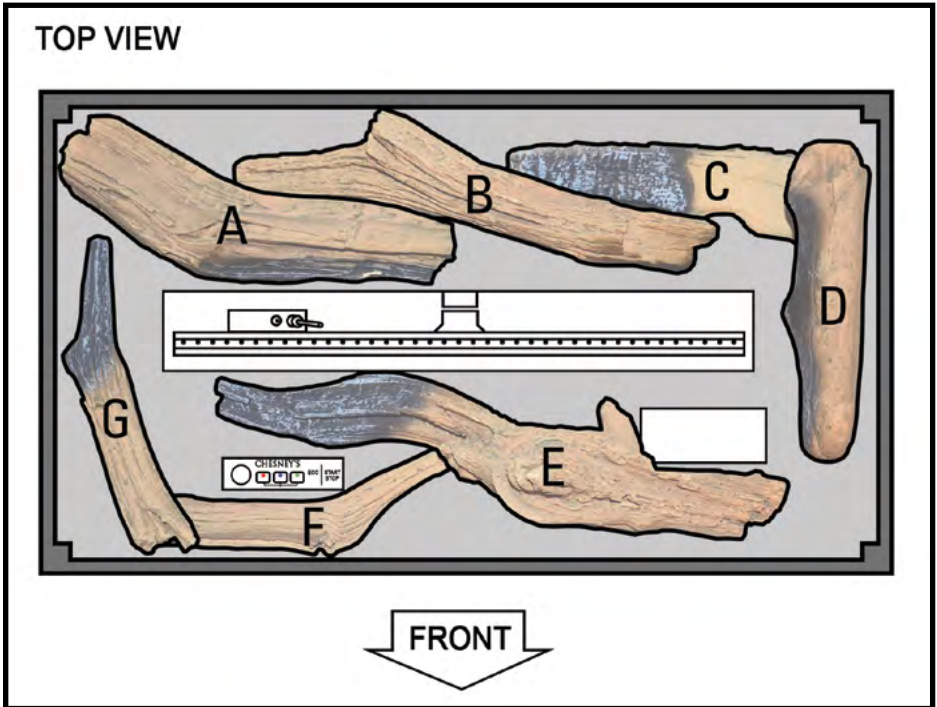

ATTENTION !!!

- Make sure that the device has been correctly installed and read the following instruction manual.
- You must not fill the fuel tank or start the device before having read the instruction manual.
- If in the future it is necessary to move the device, wait until the fuel has burned-up completely and the display shows , disconnect the power supply and only then is it safe to move the device.
- Keep this instruction manual throughout the lifetime of the device.

I. General information

The unit is a decorative appliance with real flames. Due to the innovative technology applied, the device is simple and safe to use.

II. Fuel

In order for the device to function correctly use only use fuel that is 86-96% denatured ethanol in accordance with the European Union guidelines (Directive No. 162/2013).

Using other liquids is prohibited as it may lead to incorrect functioning of the device, damage to the device and/or may cause fire or and/or health risk. The manufacturer accepts no responsibility for damage caused by using prohibited liquids such as absolute ethanol.

III. Safety

The device produces a real open fire. In order to use the device properly and safely and in order to maintain the warranty, the following safety rules should be observed:

- While installing the device in accordance with the manual one needs to observe national and local regulation.
- One needs to maintain the utmost care towards flammable materials.
- The device may only be used in a room with minimum cubic capacity of 58m³. In order to use more than one device in the same room the minimum cubic capacity required is 116m³ (4097 ft³) and for three 174m³ (6146 ft³), etc.
- It is recommended that the safety tray is regularly checked for presence of fuel. If there is fuel in the safety tray it needs to be dried.
- Only the correct fuel should be used.
- This device is not suitable for outdoor use.
- While in operation, the device emits heat, water vapour and carbon dioxide, therefore it is necessary to provide proper ventilation of the interior, ensuring that the total air exchange is at least once per hour.
- During the device's starting sequence there will be a characteristic smell of the fuel used in the device.
- Do not install the device in areas with large draughts of air, near fans,

vents, etc.

- Do not place in areas where there might be a potentially explosive atmosphere of paint vapours, industrial dusts, etc.
- Do not use the device at an ambient temperature below 10°C (50° Fahrenheit) or higher than 30°C (86° Fahrenheit).
- Install the device only on a flat, horizontal surface. Setting on an inclined surface can cause incorrect operation, permanent damage to the device or cause fire.
- No flammable items should be placed in direct contact or within a radius of 1m / 3.28 ft of the device. Do not place near curtains, net curtains, etc.
- It is obligatory to have a carbon-dioxide or dry chemical extinguisher placed nearby the device.
- An enabled device must not be moved. Wait for complete fuel burn-out and disconnect the power supply and cool down the elements before moving the device.
- The device should not be left running without adult supervision.
- Prevent handling of the device by persons not trained in its use.
- Do not attempt to make changes or repairs to the construction of the device on your own. Repairs can be made only by a person trained to service the device.
- Do not attempt to pour fuel into the device when operational, as it may cause damage of the device and cause fire. Pouring fuel into a device when operational may cause a sudden ignition and can cause fire, burns and a risk to life.
- Do not heat the fuel before starting-up the device.
- Do not start up the device if any fuel has been spilt.
- Do not cover the working device as it may cause fire.
- Keep the device and fuel away from children, pets and unauthorized persons.
- Bio ethanol fuel is not suitable for consumption. Avoid contact with skin and eyes.
- Do not operate by the fuel flap when the device is running.
- Do not tamper with the elements inside the device as this can cause a risk of burns, damage to the device or fire.

- Some elements of the device reach a high temperature. Do not touch the areas of the device adjacent to the flames as it may cause burns.
- No items should be placed on the device except those specifically approved by the manufacturer.
- Warning! The glowing coil temperature heats up to 1300°C. Touching the device while it is turned on may cause burns.
- Warning! The furnace heats up to high temperatures during operation!
- WARNING! The first run should be made only after proper installation of the device and reading the manual instructions!
- WARNING! Prior to moving the appliance burn the fuel out and move the appliance slowly, in the horizontal position, avoiding shaking. There is always some fuel left inside the device and if spilled the sensors may get wet. If this happens the appliance will not work until the liquid evaporates.

IV. Operation

This manual contains all the information necessary for the proper operation of the device. **It is obligatory to read and keep this instruction manual.** Operation of the device is permitted only after the device is properly installed according to the instructions and the manual.

A. Operating elements

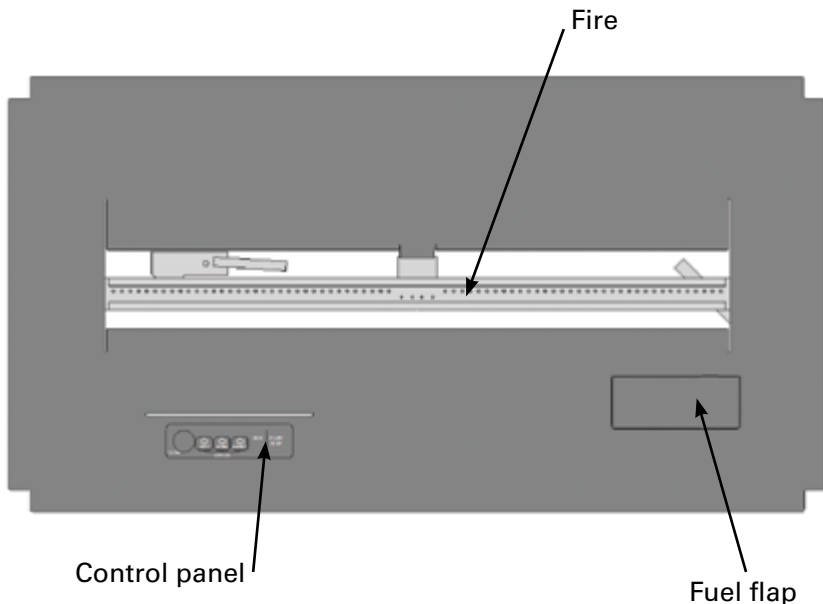

Control Panel

Service USB input hidden under a cap

Starts the device from standby mode or switches to the standby

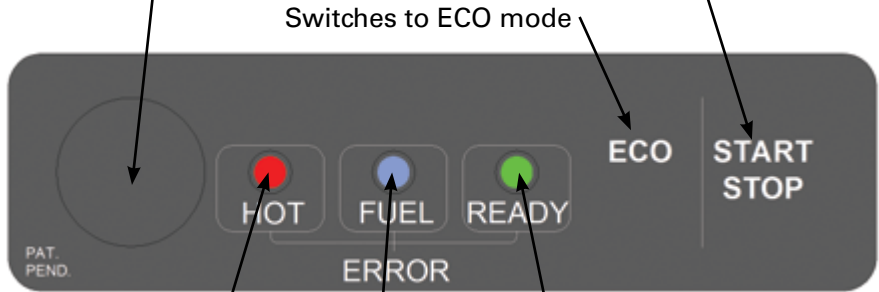

The red indicator

The blue indicator

The green indicator

B. Initial start-up of the device

1. On the control panel the blue lightflashes the lack of fuel in the tank. Please refuel.
2. Refueling.



it indicates

2.1. Open the fuel flap.

2.1. Insert the funnel

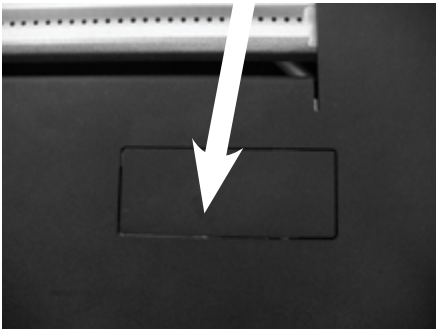



2.3 Pour the fuel into the funnel following these precautions:

- During pouring be careful not to spill fuel out of the filler. If the fuel is spilled and the error message is displayed, an alarm will be triggered and the procedure set out in the table on p.18 of the manual must be followed. If the spillage is excessive the source of power needs to be disconnected.
- If 5L containers are used for fuelling, twist on the cap with the tap onto the container and pour using the funnel. To fill up use only accessories provided by the manufacturer.



2.4 Pour the fuel to the point where the blue indicator blinks  and the intermittent beep will sound. Stop pouring! Remove the funnel.

2.5. Close the filler bolt. The green indicator  will flash on the control panel.

3. Starting the device. The green indicator flashes on the control panel. 

3.1. Press the START / STOP button on the control panel and hold for 2 seconds -You will hear a single beep.

3.2. The green indicator will blink  to indicate start-up of the device, it takes approximately 5 minutes for the appliance to ignite the flame. On the first usage this start up time may be a little longer due to the appliance needing to calibrate.

3.3. While the appliance is in work mode, the green indicator goes off and the flame starts to appear. The device works automatically until it runs out of fuel or the device is disabled by the user.

C. Flame size regulation

The device can operate in two modes: Standard and ECO. The device always starts with a standard flame size. The flame size can be adjusted during operation.

In order to reduce the height of the flame, press the ECO button. You will hear two beeps and the ECO button will be highlighted. The unit is now operating in ECO mode.

To return to the standard flame height press the ECO button, you will hear one beep and the ECO button backlight turns off. The device is now in standard mode.

ATTENTION! It might take a few moments for the flame to adjust.

ATTENTION! The device will switch to ECO mode automatically when there is any danger of the device over-heating.

D. Device extinguishing

Press the START/STOP button on the control panel. You will hear two beeps and the red indicator will start to blink



The blinking red indicator shows that the device is too hot to be restarted. When the device has cooled sufficiently the message will disappear, and depending on the amount of the fuel in the tank, either the green indicator will flash and indicate readiness for operation or the blue indicator will indicate that re-fuelling is required.

E. Subsequent start up

If the blue FUEL indicator on the control panel flashes, start to run the product from the point B.2. (p.13).

If the green READY indicator on the control panel flashes, you can:

- start to run the product from the point B.3. (p.14).
- open the fuel filler bolt - the green READY indicator will go off. If:
 - the blue indicator blinks and a beep sounds intermittently - the tank is full and no more fuel can be poured into it. Close the fuel filler bolt and proceed in accordance with section B.3. (p.14).
 - the blue indicators flashes - you can refuel (see section B.2) and turn on the device (see section B.3) or close the fuel filler bolt and activate the device by following the instructions in B.3. (p.14).

F. Information and warning alert

In order to enhance safety, the device is equipped with an electronic system to maintain safe operation. In the case of a dangerous situation, the device will immediately trigger an alarm.

LEGEND:



Indicator is off





Indicator flashes





Indicator blinking

Information and warning alerts

	Control Panel Indicators	Sound Signals		Event	Procedure
		Constant	Intermittent		
1				If the fire is not visible - NO POWER.	Make sure the device is properly connected to the power supply.
				If you see a fire - the device is in operation.	Do not leave the device unattended by an adult.
2				The device is ready for operation.	You can run the device in accordance with section B.3.
3				No fuel in the tank	Fill the fuel in accordance with B.2.
4				Initial start-up of the device	Wait for the appearance of fire, the light goes off.
5				Prevents against re-start of a device that is too hot or operation at excessive temperature level.	Allow the device to cool down. After cooling the device, the red indicator will turn off and the green indicator will start to flash.
6				The device automatically turns off due to lack of fuel in the tank.	Allow the device to cool down. After cooling the device, the red indicator will turn off

	Control Panel Indicators	Sound Signals		Event	Procedure
		Constant	Intermittent		
7			X	The fuel tank is full.	It is not allowed to pour any more fuel! Close the Fanola filler bolt. The blue indicator will turn off, the green one will start to flash.
8			X	There was a fuel spill or	Immediately stop pouring the fuel. Remove the funnel, dry visible moisture. Press the START / STOP button to turn off the sound. If the spillage is excessive the source of power needs to be disconnected. With the use of the manual pump, supplied by the manufacturer, pump out at least 1 liter of fuel from the fuel filler. Wait at least 1 hour for the remaining moisture to evaporate and then close the fuel filler bolt. Hold the ECO button for about 5 seconds. If the alarm message reappears, wait a little longer until the rest of the moisture evaporates. If the message reappears, contact your service provider.
				The acceptable device operation temperature has been exceeded.	If the alarm message appears during the start of the device, press the START / STOP button to turn off the sound and hold the ECO button for about 5 seconds. If the message reappears, contact your service provider.

	Control Panel Indicators	Sound Signals		Event	Procedure
		Constant	Intermittent		
9		X		Operation error	Press the START / STOP button to turn off the sound and hold the ECO button for about 5 seconds. If the message reappears, contact your service provider.
10		X		The device temperature has fallen below 10°C or there is a critical operation error	Press the START / STOP button to turn off the sound. Provide higher ambient temperature. Wait until the device obtains the indoor temperature. Hold down the ECO button for about 5 seconds. If the message reappears, contact your service provider.
11		X		Filler bolt protection error	Shut the filler bolt. Press the START / STOP button to turn off the sound and hold the ECO button for about 5 seconds. If the message reappears, contact your service provider.

V. Cleaning and maintenance

Switch off the device before cleaning. Wait until the temperature of the device is close to the ambient temperature. To maintain the device in good condition, please observe the following rules:



- The lacquer coating to the surface of the device is not resistant to abrasion.
- Clean the surface with a soft cloth and water to avoid causing cracks and scratches.

The inside of the device can only be cleaned by a person authorized to service the device.

The manufacturer does not foresee a situation where it will be necessary to clean elements not normally accessible.

The manufacturer is not liable for damage resulting from:

- improper operation (failure to follow instructions in the user manual)
- attempt to dismantel the device
- attempts to modify the device
- using other liquids than those recommended in point II. Fuel.

VI. Disposal and recycling

The product is equipped with parts made of aluminium, steel, plastics and electronics. If you need to dispose of the device, follow the terms of disposal and recycling in force in your country.

Dispose of the empty fuel containers using appropriate plastic waste disposal means.

If you have any technical problems or other questions that need clarification, contact the manufacturer.

Notes

